



Dixell XR60CX Operating Manual

Thank you for your purchase.

This manual contains: set-up instructions, unit specs, safety information, controller operation and maintenance steps.

K22145-C



IMPORTANT:

Your unit is preprogrammed

Place your unit in the desired location. Plug the unit in and allow it to cool and become stable for a minimum of 24 hours before logging temperature or stocking products.

Be careful when setting or changing temperatures

WARNING: Changing some controller parameters can damage your unit and/or result in a loss of product. K2 will not be held responsible for losses due to unauthorized parameter changes.



Changing advanced parameters may damage the unit or void your warranty. Please contact K2 before attempting to change advanced parameters.

Unfamiliar with the operation of a K2 controller?

Use the video tutorials on our website resources page or call us for assistance with special parameters.

Some K2 units can be changed from Celsius to Fahrenheit. We do not recommend changing your unit to Fahrenheit. Your controller has operational parameters that rely on data in Celsius to maintain proper function.

POSITIONING

- Incorrect positioning can cause damage to the equipment and generate hazardous conditions for personnel. The installer must therefore observe the following general regulations:
- Make sure you maintain a minimum of 2" (5 cm). clearance from the walls and 15" (40 cm) from the ceiling. The room must be well ventilated.
- Keep well away from sources of heat. Avoid direct sunlight
- Remove packing material.
- Remove accessories from inside the unit.
- Carton box or Wood base removal: using a hammer, tilt the cabinet to one side and loosen the two thread-forming screws, drag the cabinet from the back side holding the base still until the four castors have gone out from the containing holes, slightly tilt the cabinet backward and take the base away pulling it from the front side.

SET UP OPERATIONS

To avoid errors and accidents, perform a series of checks for possible damage sustained during transport, installation and hook-up operations before starting up the unit.

PRELIMINARY CHECKS

- Check the condition of the power cord (no cut or chaffing). Check that the door hinges and shelf support are stable.
- Check the door seals and shelves are not damaged (broken or scratched) and that the door closes and seals properly.
- Make sure all copper tubing, unions are in perfect condition.

FOR OPTIMAL PERFORMANCE

- Do not block the motor compartment air vents. Do not lay objects on the top of the equipment Before storing products wait until they are cold.
- Arrange the products on suitable shelves or in containers. Do not place products directly on the base or against the walls, doors, or fixed guards of the unit.
- Make sure doors are kept closed.
- Keep the defrost water drain outlet clear.
- Limit the frequency and duration of opening; each time the door is opened the internal temperature will alter.
- Load products at ambient temperature gradually to allow correct refrigeration. Perform routine maintenance regularly.

CONTENTS

<ol style="list-style-type: none"> 1. Front Panel Commands 2. Parameters 3. Alarm Signaling 4. Defrost 5. Default Setting Values 	<ol style="list-style-type: none"> 6. How to Use the Hot Key 7. Fans 8. Temperature Logging 9. Troubleshooting 10. Routine Maintenance
---	---

1. Front Panel Commands -QUICKGUIDE

SET

This key displays your target set point. When in programming mode, it confirms an operation.



This key starts a manual defrost



In programming mode, this key browses parameter codes or increases display value.





AUX





In programming mode, it browses the parameter codes or decreases the displayed value



Meaning

LED	MODE	SIGNIFICATO
	On	Compressor enabled
	Flashing	Anti short cycle delay enabled (AC parameter)
	On	Defrost in progress
	Flashing	Dripping in progress
	On	Fans output enabled
	Flashing	Fans delay after defrost
°C	On	Measurement unit
	Flashing	Programming mode
°F	On	Measurement unit
	Flashing	Programming mode

Key Combination



-  +  To lock or unlock the keyboard
- SET** +  To enter in programming mode
- SET** +  To return to room temperature display

Basic Parameters

How to see the set point

1. Push and immediately release the **SET** key, the set point will be shown.

How to change the set point

1. Push the SET key for 3s to change the set point value.
2. The value of the set point will be displayed and the °C or °F LED starts blinking.
3. To change the set values, push the  or  arrows.
4. To save the new set point value push the SET key again or wait 10s.

How to start a manual defrost

Push the **DEF**  book for 3s and a manual defrost will start.



Advanced Parameters

1. Enter the Programming mode by pressing the **SET** +  keys for 3s (°C or °F LED starts blinking).

SET + 

keys for more than 7s. The L2 label will be displayed immediately followed from the Hy parameter.

(NOW YOU ARE IN THE PROGRAMMING MODE)

3. Select the required parameter.
4. Press the **SET** key to display its value
5. Use  or  to change its value.
6. Press **SET** to store the new value and move to the following parameter.

To Exit: Press **SET** +  or wait 15s without pressing a key.

2. Parameters - How to change a parameter value

1. Enter the programming mode by pressing **SET+▼** keys for 3s. (°C or °F LED starts blinking)
 2. Use the up and down keys to select the required parameter. Press the **SET** key to display its value.
 3. Use **▲** or **▼** to change its value.
 4. Press **SET** to store the new value and move to the following parameter using the up and down arrows.
- To Exit: press **SET+▲** or wait 15s without pressing a key.

Changing advanced parameters may damage the unit void your warranty. Please contact K2 before attempting to change advanced parameters.

Regulation

- US Maximum SET POINT:** Set the maximum value for set point.
- ot First probe calibration:** Allows to adjust possible offset of the first probe.
- P2 Evaporator probe presence:** n= not present; y= the defrost stops by temperature.
- oE Second probe calibration:** Allows to adjust possible offset of the second probe.
- od Outputs activation delay at start up:** This function is enabled at the initial start up of the instrument and inhibits any output activation for the period of time set in the parameter.
- AC Anti-short cycle delay:** Minimum interval between the compressor stop and the following restart.
- Cy Compressor ON time with faulty probe:** Time during which the compressor is active in case of faulty thermostat probe. With Cy=0 compressor is always OFF.
- Cn Compressor OFF time with faulty probe:** Time during which the compressor is OFF in case of faulty thermostat probe. With Cn=0 compressor is always active.

Defrost

- td Defrost type:** EL= electrical heater, compressor OFF; in= hot gas, compressor ON.
- dE Defrost termination temperature:** If P2=Y it sets the temperature measured by the evaporator probe, which causes the end of defrost.
- id Interval between defrost cycles:** Determines the time interval between the beginning of two defrost cycles.
- Md Maximum length for defrost:** When P2=n, (not evaporator probe: timed defrost) it sets the defrost duration, when P2 = y (defrost end based on temperature) it sets the maximum length for defrost.
- dd Start defrost delay:** This is useful when different defrost start times are necessary to avoid overloading the plant.
- dF Display during defrost:** rt= real temperature; it= start defrost temperature; SP= SET-POINT; dF= label dF.
- dt Drip time:** Time interval between reaching defrost termination temperature and the restoring of the control's normal operation. This time allows the evaporator to eliminate water drops that might have formed due to defrost.
- dP Defrost at power –on:** y= at power on defrost starts; n= defrost doesn't start at power-on.

- CF Measurement unit:** °C =Celsius; °F =Fahrenheit.
WARNING: When the measurement unit is changed the SET point and the values of the parameters Hy, LS, US, oE, o1, AU, AL must be checked and modified if necessary.
- rE Resolution (only for °C):** dE= decimal between -9.9 and 9.9°C; in= integer
- Ld Default display:** P1= thermostat probe; P2= evaporator probe. SP=Set point (only XR04CX)
- dy Display delay:** When the temperature increases, the display is updated of 1 °C/1°F after this time.

Fans

- FC Fans operating mode:** (cn, on, cY, oY) cn= in runs with the compressor, OFF during defrost;
on= Continuous mode, OFF during defrost; cY= runs with the compressor, ON during defrost.
oY= Continuous mode, ON during defrost.
- Fd Fans delay after defrost:** (0÷99 min) Interval between end of defrost and evaporator fans start.
- FS Fans stop temperature:** (-55÷50°C / -67°F ÷ 99°F) setting of temperature, detected by evaporator probe, above which fans are always OFF.

Alarms

- AU Maximum temperature alarm:** When this temperature is reached the alarm is enabled, after the “Ad” delay time.
- AL Minimum temperature alarm:** When this temperature is reached the alarm is enabled, after the “Ad” delay time.
- Ad Temperature alarm delay:** Time interval between the detection of an alarm condition and alarm signaling.
- dA Exclusion of temperature alarm at startup:** Time interval between the detection of the temperature alarm condition after instrument power on and alarm signaling.

Digital Input

- iP Digital input polarity:** oP= activated by closing the contact; cL= activated by opening the contact.
- iF Digital input configuration:** EA= external alarm: “EA” message is displayed; bA= serious alarm “CA” message is displayed; do= door switch function; dF= defrost activation; Au= not used; Hc= inversion of the kind of action.
- di Digital input delay:** With iF=EA or bA delay between the detection of the external alarm condition and its signaling. With iF=do - delay to activate the door open alarm.
- dC Compressor and fan status when open door:** no= normal; Fn = Fans OFF; cP =Compressor OFF; Fc = Compressor and fans OFF.
- rd regulation with door open:** n = no regulation if door is opened; Y= when di is elapsed regulation restarts even if dooropen alarm is present.

3. Alarm Signaling

Code	Cause
"P1"	Room probe failure
"P2"	Evaporator probe failure
"HA"	Maximum temperature alarm
"LA"	Minimum temperature alarm
"EA"	External alarm
"CA"	Serious external alarm
"dA"	Door Open

Alarm Recovery

Probe alarms "P1" and "P2" start some seconds after the fault in the related probe; they automatically stop some seconds after the probe restarts normal operation. Check connections before replacing the probe. Temperature alarms "HA" and "LA" automatically stop as soon as the temperature returns to normal values. Alarms "EA" and "CA" (with iF=bL) recover as soon as the digital input is disabled.

Access Port

This unit is equipped with a 1/2" access port hole. For any third-party temperature monitoring device may be used within the usable space for vaccine storage.

A Probe Access Port is a small port that allows you to insert a probe for a Data Logger or Central Monitoring System into your refrigerator or freezer. Without a Probe Access Port, probes would have to be inserted through the door gasket which can prevent the door from sealing and cause performance issues. After inserting the probe through the port, the opening should be sealed with a plug or port putty. Please contact our Technical Service Department with any questions.

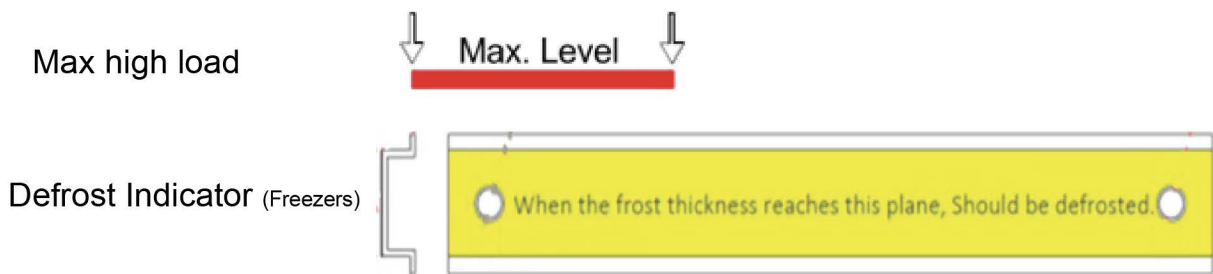

4. Manual Defrost (Freezers)

- Unplug freezer, open the door to let the ambient air defrost the chamber manually. This process normally takes about 4-5 hours.
- When it's defrosted, you will need to wipe the inside with a clean cloth, or rag to absorb the water and clean the inside chamber. When the cleaning process is completed turn the unit back on and wait for the freezer to pull down to set point.

6. How to Use the Hot Key

1. Program one controller with the front keypad.
2. When the controller is ON, insert the “Hot key” and push \wedge key; the “uP” message appears followed a by flashing “Ed”.
3. Push “SET” key and the “Ed” will stop flashing.
4. Turn OFF the instrument remove the “Hot Key,” then turn it ON again.

NOTE: the “Er” message is displayed for failed programming. In this case push again \wedge key if you want to restart the upload again or remove the “Hot key” to abort the operation.

Programming the Hot Key

1. Turn OFF the unit.
2. Insert a programmed “Hot Key” into the 5 PIN receptacle and then turn the Controller ON.
3. Automatically the parameter list of the “Hot Key” is downloaded into the Controller memory, the “do” message is blinking followed a by flashing “Ed”.
4. After 10 seconds the instrument will restart working with the new parameters.
5. Remove the “Hot Key”.

8. Temperature Logging

When storing vaccines, you may be required to perform a field validation test. A NIST calibrated external data logger may be used for this purpose. A data logger with text, email or online access is an added layer of protection for your product load in the event of a temperature excursion. K2 offers NIST calibrated data loggers to match your unit.

Control Probe

The temperature controller senses unit cooler temperature through the control probe in the unit cooler. The unit cooler temperature typically varies from the chamber temperature, so an offset value is used by the control system to compensate for the difference.

The temperature controller adjusts chamber temperature around the refrigerator setpoint by activating the compressor when the control probe registers above the setpoint based on the hysteresis value.

Calibration

Recommended calibration intervals for environmental standards used in calibrations

Standards	Initial Interval (months)	Source
Standard Thermistor	24	Accredited Lab
Data Loggers (when used for calibrations)	24	Accredited Lab

7. Fans

- **FC=cn** ➔ Will switch ON and OFF with the compressor and not run during defrost.
- **FC=on** ➔ Fans will run even if the compressor is off, and not run during defrost.

After defrosting, there is a timed fan delay allowing for driptime, set by means of the “Fd” parameter.

- **FC=cy** ➔ Fans will switch ON and OFF with the compressor and run during defrost.
- **FC=oY** ➔ Fans will run continuously also during defrost.

An additional parameter “FS” provides the setting of temperature, detected by the evaporator probe, above which the fans are always OFF. This is used to make sure circulation of air only if his temperature is lower than set in “FS”.

Fans and Digital Input

When the digital input is configured as door switch iF=do, fans and compressor status depend on the dC parameter value:

- **dC=no** normal regulation
- **dC=Fn** fans OFF
- **dC=cP** compressor OFF
- **dC=Fc** compressor and fans OFF

When **rd=y**, the regulation restart with door open alarm

9. Troubleshooting

Fault	Probable Cause	Action
The appliance is not working	The unit is plugged in correctly	Check the unit is plugged in correctly
	Plug or lead is damaged	Call our agent or qualified technician
	Power supply	Check power supply
	Internal wiring fault	Call our agent or qualified technician
The appliance turns on, but the temperature is too high or too low	Filter or condenser blocked with dust	Clean filter or condenser
	Doors are not shut properly	Check doors are shut and seals are not damaged
	Appliance is located near a heat source or air flow to the condenser is being interrupted	Move the appliance to a more suitable location
	Ambient temperature is too high	Increase ventilation or move appliance to a Low Temperature Freezer position
	Insufficient airflow to the fans	Remove any blockages to the fans
	Appliance is overloaded	Reduce the amount stored in the appliance
	Factory default parameters adjusted	Call our agent or qualified technician
The LED lights not working	Led light short Leded damage	Call our agent or qualified technician
The appliance is unusually loud	The appliance is touching a neighboring object	Check installation position and change if necessary
	The appliance has not been installed in a level or stable position	Check installation position and change if necessary

10. ROUTINE MAINTENANCE

Cleaning the interior and exterior of the appliance

- This unit is designed for the laboratory product storage, so it is important to keep it clean. The equipment is thoroughly cleaned at the factory before being shipped. Before you attempt any cleaning operation make sure the power cord is disconnected and the freezer has reached room temperature.
- Clean interior and exterior using a clean, soft cloth dampened with water and mild detergent only. Avoid electrical components. Do not use solvent or bleach. Dry with clean, soft cloth.
- The condenser is a heat exchanger. If it is dirty or clogged the air cannot circulate freely through the same, it cannot discharge heat properly so reducing proportionally the performance and the efficiency of the refrigeration system.
- **FOR THOSE REASONS IT IS IMPORTANT TO KEEP CLEAN THE CONDENSER COIL, TYPICALLY EVERY 6 MONTHS.**
- Always switch off the unit and disconnect power cord before cleaning, it is dangerous to do it with power ON: fan may start suddenly at any time.

GENERAL SAFETY REGULATIONS

 Do not use this product with flammable gases or flammable solvents.

 Do not store flammable gases, flammable liquids, or flammable solids in these units.

Primary general safety regulations:

- Do not touch the unit with wet hands and/or feet. Do not use the equipment with bare feet.
- Do not insert screwdrivers or other pointed objects between guards or moving parts of the equipment.
- Do not pull the power cord to disconnect the equipment from the electrical mains Make sure that the equipment is not used by unsuitably qualified persons.
- Before performing any cleaning or maintenance on the equipment disconnect it from the electrical mains by switching off the main switch and extracting the plug.
- **Never** use any metallic scouring pads, brushes, abrasive cleaners, or strong alkaline solution on any surface.
- The relocation of the unit must be performed by qualified personnel. Do not shift the refrigerator from side to side as this may create leakage point across the cooling unit piping.
- In case of faults or malfunctions, unplug the equipment and do not attempt to repair it by yourself as doing so may void the warranty. All service and repair operations must be performed exclusively by a manufacture's authorized engineer. (Authorized service technician, trained service personnel, authorized service personnel)

Service

K2 Scientific want to make sure you are happy with your purchase. There are several ways for you to contact us with questions or service needs. Be sure to include your four-digit order number or at least your model number handy to speed up the process.

1: Contact us via our chat feature at www.k2sci.com

2: Email support@k2sci.com

To ensure safe travel your door handle, locking mechanism, and casters have not been installed to prevent damage during shipment. Follow the instructions below to install these items prior to start up of the unit. Contact support@k2sci.com if you have any questions or concerns with the installation process.

DOOR HANDLE INSTALLATION

1. Fix the handle on the door with six screws.
2. Press the cover into the handle pedestal.
3. Handle installation completed.

LATCH HOOK INSTALLATION

1. Take off the tape covered on the hole.
2. Match the latch hook holes with the holes and attached the two screws.

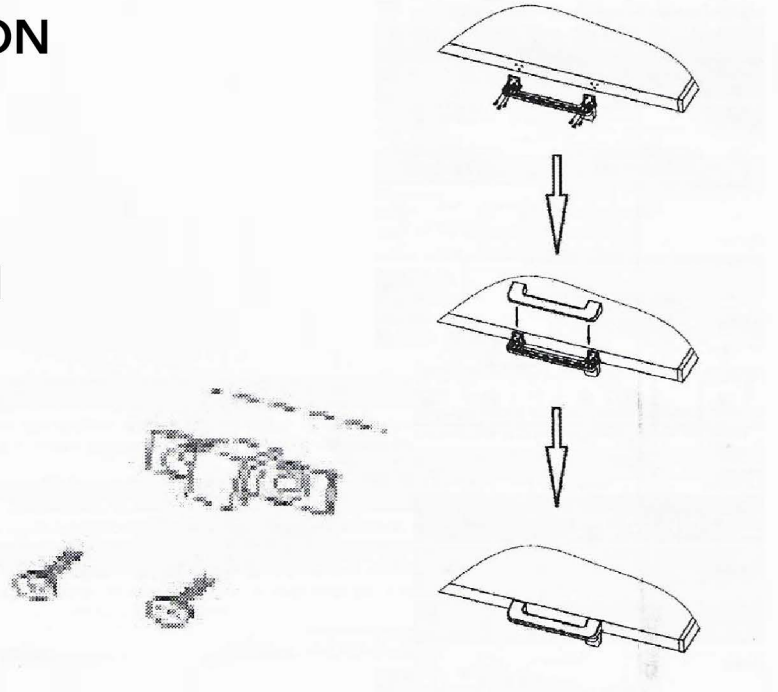

CASTER INSTALLATION

Before beginning please make sure you have time to complete this installation. Installation requires tilting of the unit which will cause cooling fluids to disperse from the reservoir into the cooling system. This is not an issue as it is a closed system and the cooling system will adjust when the unit is uprighted. Please allow the unit to sit unplugged and without start up for 24 hours after completing the installation to allow the cooling fluids to return to the proper position in the system. **DO NOT START THE UNIT SOONER THAN 24 HOURS OF RESTING UPRIGHT POSITIONING.**

1. Place the back of the freezer on the floor to facilitate the installation of casters.
(Please protect the surface of the freezer to avoid scratches).
2. Take the wheels from the carton and align them with the 4 holes at the bottom of the freezer which spacing.
3. Align the holes in the wheels with the four holes in the bottom, install and tighten.

